

# SOLO

AUTOMATIONDIRECT.com

3505 HUTCHINSON ROAD  
CUMMING, GA 30040-5860

## Quick Start Guide

### SOLO Temperature Controller

#### SL4848 Series



This Quick Start Guide provides basic information on setting up the SOLO temperature controller. For advanced setup and communication control as well as free configuration software visit the AutomationDirect web site at [www.AutomationDirect.com](http://www.AutomationDirect.com).

### Product Support and Configuration Software

- For product support, specifications, and installation troubleshooting, a complete User Manual can be downloaded from the On-line Documentation area of the **AutomationDirect** web site.
- For additional technical support and questions, call our Technical Support team @ 1-800-633-0405 or 770-844-4200.
- Configuration software for the SOLO controller is available for free download at [www.AutomationDirect.com](http://www.AutomationDirect.com). The software allows communication and programming for up to four controllers at the same time. Parameters, process values, set points and temperature changes can be monitored with the software. The setup data can be uploaded to the user's PC via RS-485 communication. The user can monitor the temperature changes of the controllers from the "PV Monitor" Display.



### 1 Safety Information

**WARNING:** To minimize the risk of potential safety problems, you should follow all applicable local and national codes that regulate the installation and operation of your equipment. These codes vary from area to area and it is your responsibility to determine which codes should be followed, and to verify that the equipment, installation, and operation are in compliance with the latest revision of these codes.

*Equipment damage or serious injury to personnel can result from the failure to follow all applicable codes and standards. We do not guarantee the products described in this publication are suitable for your particular application, nor do we assume any responsibility for your product design, installation, or operation.*

If you have any questions concerning the installation or operation of this equipment, or if you need additional information, please call us at 1-800-633-0405 or 770-844-4200.

This publication is based on information that was available at the time it was printed. At **AutomationDirect.com** we constantly strive to improve our products and services, so we reserve the right to make changes to the products and/or publications at any time without notice and without obligation. This publication may also discuss features that may not be available in certain revisions of the product.

**WARNING!** Electric shock danger

- To prevent electric shock, do not touch the AC terminals while the power is supplied to the controller.

**WARNING!** This controller is an open-type temperature controller. Make sure to evaluate any dangerous application in which a serious human injury or serious property damage may occur.

- Always use recommended solder-less terminals: Fork terminal with insulation (M3 screw, width is 7.0mm, hole diameter 3.2mm). Screw size: M3 x 6.5 (With 6.8 x 6.8 square washer). Recommended tightening torque: 0.4 Nm (4kgfcm). Applicable wire: Solid/twisted wire of 2 mm, 12AWG to 24AWG. Choose AutomationDirect part numbers BM-00120, BM-00220 or BM-00320 depending on wire size. Be sure to tighten them properly.
- Protect the controller from dust or foreign objects to prevent controller malfunction.
- Do not modify or disassemble the controller.
- Do not connect anything to the "Not used" terminals.
- Make sure all wires are connected correctly.
- Do not install and/or use the controller in places subject to: (a) Dust or corrosive gases and liquid (b) High humidity (c) Vibration and shock (d) EMI / RFI (e) high temperature.
- Turn power off when wiring or changing a temperature sensor.
- Be sure to use wires that match the thermocouple types when extending or connecting the thermocouple wires.
- Use wires with correct resistance when extending or connecting a platinum resistance thermometer (RTD).
- Keep the wire as short as possible when wiring a platinum resistance thermometer (RTD) to the controller and route power wires as far as possible from load wires to prevent interference and induced noise.
- This controller is an open-type unit and must be placed in an enclosure away from high temperature, humidity, dripping water, corrosive materials, airborne dust and electric shock or vibration.
- Make sure power cables and signals from instruments are all installed properly before energizing the controller, otherwise serious damage may occur.
- To prevent electric shock, do not touch the terminals in the controller or try to repair the controller when power is applied.
- Use a soft, dry cloth to clean the controller. Do not use acid or alkaline liquids for cleaning.
- This instrument is not furnished with a power switch or fuse. Therefore, if a fuse or power switch is required, install the protection close to the instrument. Recommended fuse rating: Rated voltage 250 V, Rated current 1 A. Fuse type: Time-lag fuse
- Note: This controller does not provide overcurrent protection. Use of this product requires that suitable overcurrent protection device(s) must be added to ensure compliance with all relevant electrical standards and codes. (Rated 250 V, 15 Amps max). A suitable disconnecting device should be provided near the controller in the end-use installation.

### 2 General Description

AutomationDirect's SOLO is a single loop dual output temperature controller that can control both heating and cooling simultaneously. There are four types of control modes: PID, ON/OFF, Manual, and Ramp / Soak control. Depending upon the particular model of controller, the available outputs include relay, voltage pulse, current, and linear voltage. There are up to three alarm outputs available to allow seventeen alarm types in the initial setting mode. SOLO can accept various types of thermocouple, RTD, or analog inputs, and has a built in RS-485 interface using Modbus slave (ASCII or RTU) communication protocol.

Other features include:

- 1/16 DIN panel size
- 2 line x 4 character 7-segment LED display for Process Value (PV): Red color, and Set Point (SV): Green color
- Auto Tuning (AT) function with PID control
- Selectable between °C and °F for thermocouple or RTD inputs
- 0 to 50 °C (32 to 122 °F) operating temperature range
- UL, CUL and CE agency approvals

### 3 Specifications

Specifications	
<b>Input Power Requirements</b>	100 to 240 VAC 50 / 60 Hz or 24 VDC
<b>Operation Voltage Range</b>	85 to 264 VAC or 21.6 to 26.4 VDC
<b>Power Consumption</b>	5 VA Max
<b>Memory Protection</b>	EEPROM 4K bit, number of writes 100,000
<b>Control Mode</b>	PID, ON/OFF, Ramp / Soak control or Manual
<b>Input Accuracy</b>	Less than ± 0.2% full scale (except thermocouple R, S, & B types) Max ± 3° (thermocouple R, S, & B types)
<b>Vibration Resistance</b>	10 to 55 Hz, 10 m/s <sup>2</sup> for 10 min, each in X, Y and Z directions
<b>Shock Resistance</b>	Max. 300 m/s <sup>2</sup> , 3 times in each 3 axes, 6 directions
<b>Ambient Temperature Range</b>	32°F to 122°F (0°C to 50°C)
<b>Storage Temperature Range</b>	-4°F to 149°F (-20°C to 65°C)
<b>Altitude</b>	2000m or less
<b>Relative Humidity</b>	35% to 80% (non-condensing)
<b>RS-485 Communication</b>	Modbus slave ASCII / RTU protocol
<b>Transmission Speed</b>	2400, 4800, 9600, 19.2K, 38.4K bps
<b>IP Rating</b>	IP65: Complete protection against dust and low pressure spraying water from all directions. (inside suitable enclosure)
<b>Agency Approvals</b>	UL, CUL, CE (UL file number E311366)
<b>Pollution Degree</b>	Degree 2 - Normally, only non-conductive pollution occurs. Temporary conductivity caused by condensation is to be expected.
<b>Input Types</b>	
• Thermocouple*	K, J, T, E, N, R, S, B, L, U, TXK (Sampling Rate: 400 ms / per scan)
• Platinum RTD	3-wire Pt100, JPt100 (Sampling Rate: 400 ms / per scan)
• Analog	0-50 mV, 0-5V, 0-10V, 0-20 mA, 4-20 mA (sinking) (150 ms per scan)**
<b>Control Output Options</b>	
• Relay (R)	SPST max. resistive load 5A @ 250 VAC
• Voltage Pulse (V)	DC 14V Max, output current 40mA Max
• Current (C)	DC 4-20 mA output (sourcing) (Load resistance: Max 600Ω)
• Linear Voltage (L)	DC 0-10V (Load resistance Min 1KΩ)

\*Note: Use only ungrounded thermocouples.

\*\* Analog input impedance: 1.8MΩ

\*Note: The supplied 249 ohm resistor should be installed as shown in the terminal wiring diagrams in section 7 for current input operation.

Output Specifications					
Part Number	Input Voltage	Output #1	Output #2 / Alarm #3*	Alarm #1**	Alarm #2**
SL4848-RR	100 - 240 VAC	Relay - SPST	Relay - SPST	Relay - SPST	Relay - SPST
SL4848-VR	100 - 240 VAC	Voltage Pulse	Relay - SPST	Relay - SPST	Relay - SPST
SL4848-CR	100 - 240 VAC	Current	Relay - SPST	Relay - SPST	Relay - SPST
SL4848-LR	100 - 240 VAC	Linear Voltage	Relay - SPST	Relay - SPST	Relay - SPST
SL4848-RR-D	24 VDC	Relay - SPST	Relay - SPST	Relay - SPST	Relay - SPST
SL4848-VR-D	24 VDC	Voltage Pulse	Relay - SPST	Relay - SPST	Relay - SPST
SL4848-CR-D	24 VDC	Current	Relay - SPST	Relay - SPST	Relay - SPST
SL4848-VV	100 - 240 VAC	Voltage Pulse	Voltage Pulse	Relay - SPST	Relay - SPST
SL4848-CV	100 - 240 VAC	Current	Voltage Pulse	Relay - SPST	Relay - SPST
SL4848-LV	100 - 240 VAC	Linear Voltage	Voltage Pulse	Relay - SPST	Relay - SPST

\*Output #2 can be configured as control output #2 or as Alarm #3

\*\*Alarm #1 and Alarm #2 have a shared common

### 4 Box Contents and Unpacking Instructions

- Unpack the SOLO temperature controller from its shipping carton. Included in the carton is the temperature controller, mounting brackets plus hardware and this Quick Start Guide.
- Inspect all equipment for completeness. If anything is missing or damaged, immediately call the **AutomationDirect** returns department @ 1-800-633-0405.
- Inspect the part number to ensure the model received matches the output type required.

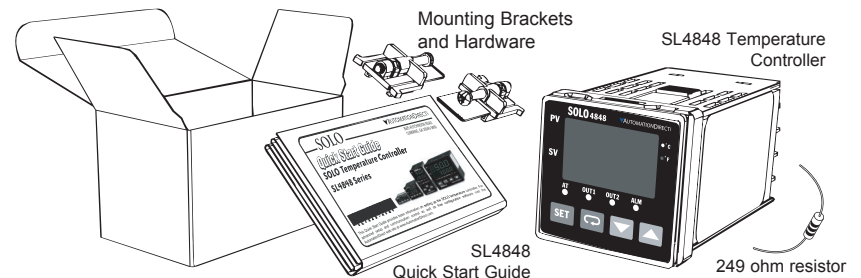

### 5 Controller and Panel Cutout Dimensions

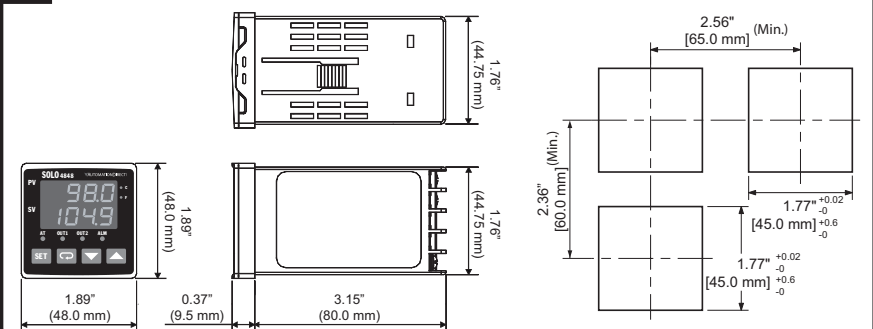

## 6 Mounting Instructions

SOLO temperature controllers can be mounted through a cutout in an enclosure or panel by using the dimensions shown in Section 5. The directions for mounting the controller through a cutout are:

1. Insert the temperature controller through the panel cutout.
2. Slide the M3X0.5 nut into the opening in the top of the mounting bracket and insert the M3X0.5 X 30mm mounting screw in the mounting bracket.
3. Insert the mounting bracket into the mounting groove at the top and bottom of the controller, and push the mounting bracket forward until the bracket stops.
4. Tighten top and bottom screws evenly to secure temperature controller in place.

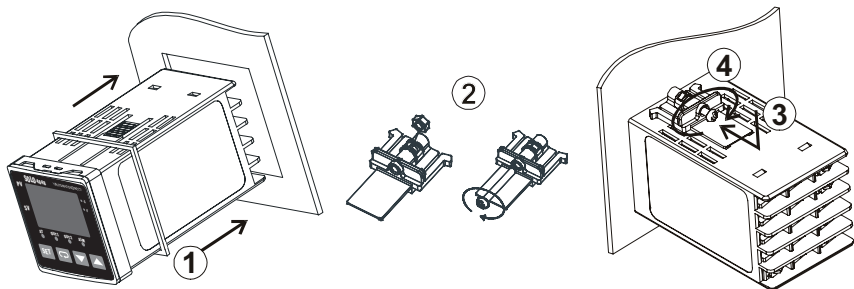

## 7 Terminal Identification

### WARNING! Electric shock danger

To prevent electric shock, do not connect AC power to your device until all input and output connections are completed.

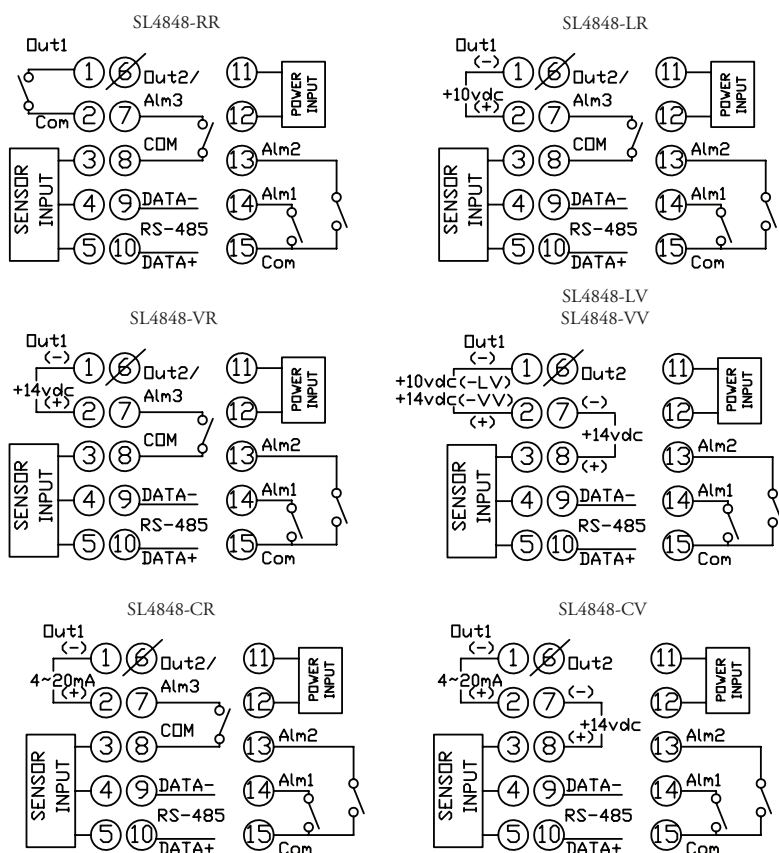

### Sensor Input

For 4~20mA sensor input install supplied 249Ω resistor.

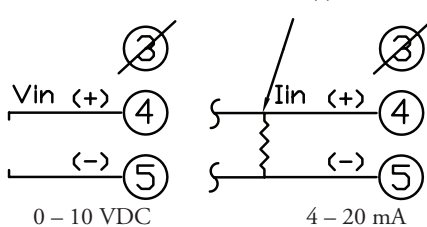

Install jumper when using 2 wire RTD

2-wire RTD

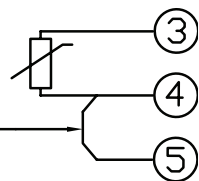

Thermocouple

3-wire RTD

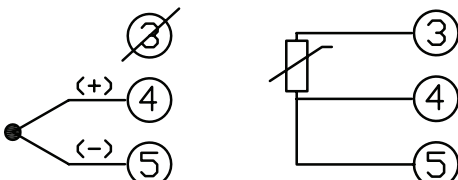

### Power Input

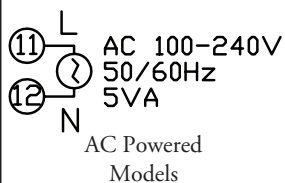

AC Powered Models

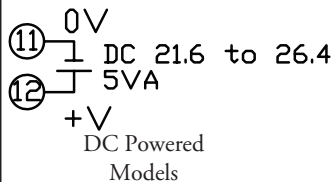

DC Powered Models

24 VDC power for models with -D suffix only

## 8 Display, LED and Key Pad



PV Display: To display the process value or parameter type.

SV Display: To display the set point, parameter operation read value manipulated variable or set value of the parameter.

AT: Auto-tuning LED, flashes when the Auto-tuning operation is ON.

OUT1 / OUT2: Output LED, lights when the output is ON.

ALM: Alarm output LED, lights when one of the alarms is on.

°C, °F: Temperature unit LED. °C: Celsius °F: Fahrenheit

**SET** Set Button: Press this key to select the desired function mode and confirm the setting value.

**↺** Rotate Button: Press this key to select parameters within the function mode.

**▼** Down Button: Press this key to decrease values displayed on the SV display. Hold down this key to speed up the decrement.

**▲** Up Button: Press this key to increase values displayed on the SV display. Hold down this key to speed up the increment.

## 9 Key Pad Operation

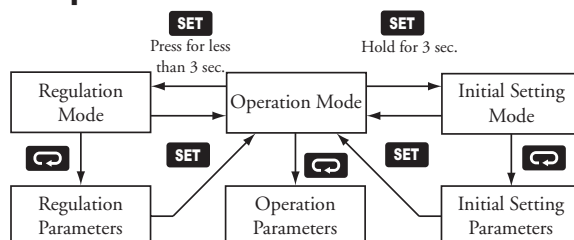

The SOLO temperature controller has three function modes: Initial Setting mode, Operation mode and Regulation mode. When power is first applied to the temperature controller, the module information splash screen appears. This screen shows the firmware version on the PV display and the two output types for that particular model on the SV display. After three seconds, the controller will automatically proceed to the Operation mode main screen. Press and hold the **SET** button for three seconds to go into the Initial Setting mode. Press the **SET** button for less than three seconds to access the Regulation mode. Press the **↺** button while inside any of the three function modes to access the individual parameters for each function mode. Use the **▲** and **▼** buttons to change the individual parameter values. Pressing the **SET** button saves the parameter values. Press the **SET** button again to return the controller to the Operation mode.

## 10 Reset to Factory Default Instructions

All of the following set up instructions are for setting up a controller from the factory defaults. If the application for a controller needs to be changed, reset the controller to factory default using the following steps.

1. Press the **↺** button until the parameter **LoC** appears. Use the **▲** button to select **LoC**. Press the **SET** button.
2. Press and hold the **▼** and **▲** buttons simultaneously for one second and release.
3. Press the **↺** button repeatedly until the PV display shows **PASS**. Use the **▼** button to change the value on the SV display to **135**. Press the **SET** button.
4. Cycle power on the Controller to reset to factory default mode. All user set values are erased.

## 11-1 Thermocouple or RTD Input

1. Access the Initial Setup mode by pressing and holding the **SET** button for three seconds. In the parameter **TPH**, use the **▼** and **▲** buttons to select the value that corresponds to the thermocouple or RTD type that will be attached to the controller. See the table below for specifications. Press the **SET** button to save the selected value. The controller will display the module information splash screen for three seconds and then return to the main screen.

2. Press the **SET** button for three seconds again. Press the **↺** button to access the **EPUN** parameter. Use the **▼** and **▲** buttons to select either **C** for Centigrade or **F** for Fahrenheit display. Press the **SET** button to save the selected value. The controller will display the module information splash screen for three seconds and then return to the main screen.

3. Press the **SET** button for three seconds again. Press the **↺** button repeatedly until the **EP-H** parameter appears. Use the **▼** and **▲** buttons to set the maximum value of the operational temperature range. In operation, if the PV value is higher than the TP-H value, the PV display flashes to indicate an error and the controller outputs shut off. The SV value cannot exceed the TP-H value. Press the **SET** button to save the selected value. Press the **↺** button to access the **EP-L** parameter. Use the **▼** and **▲** buttons to set the minimum value of the operational temperature range. In operation, if the PV value is lower than the TP-L value, the PV display flashes to indicate an error and the controller outputs shut off. The SV value cannot be set lower than the TP-L value. Press the **SET** button twice to save the selected value and return to the controller main screen.

4. Press the **↺** button repeatedly until the parameter **SP** appears. Use the **▼** and **▲** buttons to select either **1** for a whole degree or **10** for a tenth degree temperature display.\* Press the **SET** button twice to save the selected value and return to the controller main screen.

5. If the input temperature from the thermocouple or RTD needs to be adjusted, press the **SET** button for less than 3 seconds. Press the **↺** button repeatedly until the parameter **EPoF** appears. Use the **▼** and **▲** buttons to adjust a positive or negative offset to the PV value displayed on the controller. Press the **SET** button twice to save the selected value and return to the controller main screen.

\*Note: The decimal point display cannot be adjusted for B, S, and R type thermocouples.

Thermocouple* Type and Temperature Range		
Input Temperature Sensor Type	LED Display	Temperature Range
Thermocouple TXK type	TXK	-328 ~ 1472°F (-200 ~ 800°C)
Thermocouple U type	U	-328 ~ 932°F (-200 ~ 500°C)
Thermocouple L type	L	-328 ~ 1562°F (-200 ~ 850°C)
Thermocouple B type	B	-212 ~ 3272°F (100 ~ 1800°C)
Thermocouple S type	S	32 ~ 3092°F (0 ~ 1700°C)
Thermocouple R type	R	32 ~ 3092°F (0 ~ 1700°C)
Thermocouple N type	N	-328 ~ 2372°F (-200 ~ 1300°C)
Thermocouple E type	E	32 ~ 1112°F (0 ~ 600°C)
Thermocouple T type	T	-328 ~ 752°F (-200 ~ 400°C)
Thermocouple J type	J	-148 ~ 2192°F (-100 ~ 1200°C)
Thermocouple K type	K	-328 ~ 2372°F (-200 ~ 1300°C)
RTD Type and Temperature Range		
Input Temperature Sensor Type	LED Display	Temperature Range
Platinum Resistance (PT100)	PT	-328 ~ 1112°F (-200 ~ 600°C)
Platinum Resistance (JPT100)	JPT	-4 ~ 752°F (-20 ~ 400°C)

\*Note: Use only ungrounded thermocouples.

## 11-2 Voltage Input

1. Access the Initial Setup mode by pressing and holding the **SET** button for three seconds. In the parameter **ENPE**, use the **▼** and **▲** buttons to select the value that corresponds to the voltage input that will be applied to the controller. See the table for voltage specifications. Press the **SET** button to save the selected value. The controller will display the module information splash screen for three seconds and then return to the main screen.
2. Press the **SET** button for three seconds again. Press the **☐** button to access the parameter **EP-H**. Use the **▼** and **▲** buttons to select the high engineering value that corresponds to the maximum voltage signal that will be applied to the input of the controller. For example, if the **US** 0V-5V input is to be used, this is the value the controller will display when the input equals 5V. Press the **SET** button to save the selected value. Press the **☐** button to access the parameter **EP-L**. Use the **▼** and **▲** buttons to select the low engineering value that corresponds to the minimum voltage signal that will be applied to the input of the controller. For example, if the **US** 0V-5V input is to be used, this is the value the controller will display when the input equals 0V. Press the **SET** button twice to save the selected value and return to the controller main screen.
3. Press the **☐** button repeatedly until the parameter **SP** appears. Use the **▼** and **▲** buttons to select **0**, **1**, **2** or **3** to indicate the position of the decimal point for the PV and SV values on the controller. Press the **SET** button twice to save the selected value and return to the controller main screen.
4. If the voltage input PV value displayed on the controller needs to be adjusted, press the **SET** button for less than 3 seconds. Press the **☐** button repeatedly until the parameter **EPoF** appears. Use the **▼** and **▲** buttons to adjust a positive or negative offset to the PV value displayed on the controller. Press the **SET** button twice to save the selected value and return to the controller main screen.

Voltage Input Type and Input Range		
Voltage Input Type	LED Display	Engineering Range
0-50mV Analog Input	FD	-999 ~ 9999
0V-10V Analog Input	UFD	-999 ~ 9999
0V-5V Analog Input	US	-999 ~ 9999

## 11-3 Current Input

1. Install the supplied 249 ohm resistor between terminal #4 and #5.
2. Access the Initial Setup mode by pressing and holding the **SET** button for three seconds. In the parameter **ENPE**, use the **▼** and **▲** buttons to select the value that corresponds to the current input that will be applied to the controller. See the table for current specifications. Press the **SET** button to save the selected value. The controller will display the module information splash screen for three seconds and then return to the main screen.
3. Press the **SET** button for three seconds again. Press the **☐** button repeatedly until the parameter **EP-H** appears. Use the **▼** and **▲** buttons to select the high engineering value that corresponds to the maximum current signal that will be applied to the input of the controller. For example, if the **FR4** 4-20mA input is to be used, this is the value the controller will display when the input equals 20mA. Press the **SET** button to save the selected value. Press the **☐** button to access the parameter **EP-L**. Use the **▼** and **▲** buttons to select the low engineering value that corresponds to the minimum current signal that will be applied to the input of the controller. For example, if the **FR4** 4-20mA input is to be used, this is the value the controller will display when the input equals 4mA. Press the **SET** button twice to save the selected value and return to the controller main screen.
4. Press the **☐** button repeatedly until the parameter **SP** appears. Use the **▼** and **▲** buttons to select **0**, **1**, **2** or **3** to indicate the position of the decimal point for the PV and SV values on the controller. Press the **SET** button twice to save the selected value and return to the controller main screen.
5. If the current input PV value displayed on the controller needs to be adjusted, press the **SET** button for less than 3 seconds. Press the **☐** button repeatedly until the parameter **EPoF** appears. Use the **▼** and **▲** buttons to adjust a positive or negative offset to the PV value displayed on the controller. Press the **SET** button twice to save the selected value and return to the controller main screen.

Current Input Type and Range		
Current Input Type	LED Display	Engineering Range
4-20mA Analog Input	FR4	
0-20mA Analog Input	FR0	-999 ~ 9999

## 12-1 PID Control Setup

**Note:** Select the desired control mode before beginning PID Control Setup.

There are four groups for storing PID parameters, **PCD0** (PID0) - **PCD3** (PID3). Press the **SET** button for less than three seconds and press the **☐** button repeatedly until the parameter **PCD0** appears. Use the **▼** and **▲** buttons to select which group to use for storing the PID parameters. Press the **SET** button to confirm the setting. The groups **PCD0** - **PCD3** can be individually set up with different SV values to be used in the control process. If the group **PCD4** is selected, the controller will automatically select the most useful PID parameters based on the current temperature setting and the SV value set in each PID group.

The parameters for PID can be auto-tuned using the **AE** parameter. Access this parameter by pressing the **SET** button for less than three seconds. Use the **▲** button to turn the auto-tune feature **ON**. Press the **SET** button to save the value. Optimal PID values are automatically determined with the auto-tune feature. PID operation can also be controlled by programming the individual **P**, **I**, and **D** parameters for each PID group. Access these parameters by pressing the **SET** button for less than three seconds and press the **☐** button repeatedly until the parameter **Pn** appears where **n** corresponds to the PID group you are programming. Use the **▼** and **▲** buttons to change the value for the Proportional band if desired and press the **SET** button to save the value. Press the **☐** button to access the **In** parameter. Use the **▼** and **▲** buttons to change the value for the Integral time if desired and press the **SET** button to save the value. Press the **☐** button to access the **Dn** parameter. Use the **▼** and **▲** buttons to change the value for the Derivative time if desired and press the **SET** button twice to save the value and return to the controller main screen.

## 12-2 Heating Loop with PID Control

1. Access the Initial Setup mode by pressing and holding the **SET** button for three seconds. Press the **☐** button repeatedly until the parameter **Ctrl** appears. Confirm the default value **PCD** is selected for PID control. Press the **☐** button to access the parameter **S-HC**. Confirm the default value **HEAT** is selected for controlling a heating loop. Press the **SET** button to return to the controller main screen.
2. Press the **☐** button to access the parameter **r-s**. Verify that the default value **rUn** is selected. Press the **SET** button to return to the controller main screen.
3. Refer to Section 12-1 of this Quick Start Guide to set up the PID control parameters.
4. If the temperature controller's output #1 is discrete, access the regulation mode again by pressing the **SET** button for less than three seconds. Press the **☐** button repeatedly until the parameter **HEPd** appears. Use the **▼** and **▲** buttons to set the time period in seconds for the heating control. Press the **SET** button twice to save the value and return to the controller main screen.

## 12-3 Heating Loop with ON / OFF Control

1. Access the Initial Setup mode by pressing and holding the **SET** button for three seconds. Press the **☐** button repeatedly until the parameter **Ctrl** appears. Use the **▼** and **▲** buttons to select **ON/OFF** for ON / OFF control. Press the **SET** button to save the value. Press the **☐** button to access the parameter **S-HC**. Confirm the default value **HEAT** is selected for controlling a heating loop. Press the **SET** button to return to the controller main screen.
2. Press the **☐** button to access the parameter **r-s**. Verify that the default value **rUn** is selected. Press the **SET** button to return to the controller main screen.
3. Press the **SET** button for less than three seconds to access the parameter **HEs**. Use the **▼** and **▲** buttons to enter hysteresis. This is the amount the PV must go below the SV before the controller output turns on. Press the **SET** button twice to save the selected value and return to the controller main screen.

## 12-4 Cooling Loop with PID Control

1. Access the Initial Setup mode by pressing and holding the **SET** button for three seconds. Press the **☐** button repeatedly until the parameter **Ctrl** appears. Confirm the default value **PCD** is selected for PID control. Press the **☐** button to access the parameter **S-HC**. Use the **▲** button to select **COOL** for controlling a cooling loop. Press the **SET** button twice to save the value and return to the controller main screen.
2. Press the **☐** button to access the parameter **r-s**. Verify that the default value **rUn** is selected. Press the **SET** button to return to the controller main screen.
3. Refer to Section 12-1 of this Quick Start Guide to set up the PID control parameters.
4. If the temperature controller's output #1 is discrete, access the regulation mode again by pressing the **SET** button for less than three seconds. Press the **☐** button repeatedly until the parameter **CLPd** appears. Use the **▼** and **▲** buttons to set the time period in seconds for the cooling control. Press the **SET** button twice to save the value and return to the controller main screen.

## 12-5 Cooling Loop with ON / OFF Control

1. Access the Initial Setup mode by pressing and holding the **SET** button for three seconds. Press the **☐** button repeatedly until the parameter **Ctrl** appears. Use the **▼** and **▲** buttons to select **ON/OFF** for ON / OFF control. Press the **SET** button to save the value. Press the **☐** button to access the parameter **S-HC**. Use the **▲** button to select **COOL** for controlling a cooling loop. Press the **SET** button twice to save the value and return to the controller main screen.
2. Press the **☐** button to access the parameter **r-s**. Verify that the default value **rUn** is selected. Press the **SET** button to return to the controller main screen.
3. Press the **SET** button for less than three seconds to access the parameter **CEs**. Use the **▼** and **▲** buttons to enter hysteresis. This is the amount the PV must go above the SV before the controller output turns on. Press the **SET** button twice to save the selected value and return to the controller main screen.

## 12-6 Dual Heating / Cooling Loop with PID Control

1. Access the Initial Setup mode by pressing and holding the **SET** button for three seconds. Press the **☐** button repeatedly until the parameter **Ctrl** appears. Confirm the default value **PCD** is selected for PID control. Press the **☐** button to access the parameter **S-HC**. Use the **▲** button to select **H/C2** for controlling a dual heating / cooling loop. This parameter sets the heating control to output #1 and the cooling control to output #2. Press the **SET** button twice to save the value and return to the controller main screen.
2. Press the **☐** button to access the parameter **r-s**. Verify that the default value **rUn** is selected. Press the **SET** button to return to the controller main screen.
3. Refer to Section 12-1 of this Quick Start Guide to set up the PID control parameters.
4. If the temperature controller's output #1 is discrete, access the regulation mode again by pressing the **SET** button for less than three seconds. Press the **☐** button repeatedly until the parameter **HEPd** appears. Use the **▼** and **▲** buttons to set the time period in seconds for output #1, the heating control. Press the **SET** button to save the value. If the temperature controller's output #2 is discrete, press the **☐** button repeatedly until the parameter **CLPd** appears. Use the **▼** and **▲** buttons to enter the cycle period in seconds for output #2, the cooling output. Press the **SET** button twice to save the value and return to the controller main screen.
5. Optional regulation parameters can be programmed for a second control output. If this is desired, access the regulation mode again by pressing the **SET** button for less than three seconds. Press the **☐** button repeatedly until the parameter **DEAD** appears. This value allows the cooling control to have a different proportional setting than the heating loop. The heating loop proportional band setting is multiplied by the **COEF** value to create a proportional band setting for the cooling loop control. Use the **▼** and **▲** buttons to change this value if desired. Press the **SET** button to save the selected value. Press the **☐** button to access the parameter **DEAD**. Use the **▼** and **▲** buttons to enter a deadband zone value around the setpoint where the output is not effected by the proportional control value. As long as the PV remains within the deadband zone the output is not affected by the proportional control. The integral and derivative controls ignore the deadband setting and may cause the output to be on within the deadband zone. Press the **SET** button twice to save the value and return to the controller main screen.

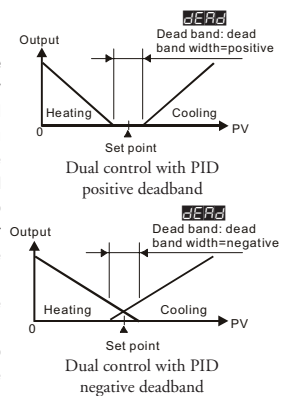

## 12-7 Dual Heating / Cooling Loop with ON / OFF Control

1. Access the Initial Setup mode by pressing and holding the **SET** button for three seconds. Press the **☐** button repeatedly until the parameter **Ctrl** appears. Use the **▼** and **▲** buttons to select **ON/OFF** for ON / OFF control and press the **SET** button to save the selected value. Press the **☐** button to access the parameter **S-HC**. Use the **▲** button to select **H/C2** for controlling a cooling / heating loop. This parameter sets the heating control to output #1 and the cooling control to output #2. Press the **SET** button twice to save the value and return to the controller main screen.
2. Press the **☐** button to access the parameter **r-s**. Verify that the default value **rUn** is selected. Press the **SET** button to return to the controller main screen.
3. Press the **SET** button for less than three seconds to access the parameter **HEs**. Use the **▼** and **▲** buttons to enter hysteresis for output #1, the heating control. This is the amount the PV must go below the SV before the controller output turns on. Press the **SET** button to save the selected value. Press the **☐** button to access the parameter **CEs**. Use the **▼** and **▲** buttons to enter hysteresis for output #2, the cooling control. This is the amount the PV must go above the SV before the controller output turns on. Press the **SET** button twice to save the selected value and return to the controller main screen.

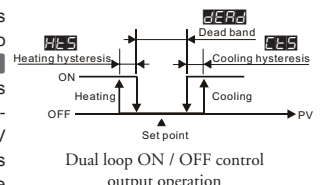

4. Optional regulation parameters can be programmed for additional dual loop control. If this is desired, access the regulation mode again by pressing the **SET** button for less than three seconds. Press the **☐** button repeatedly until the parameter **DEAD** appears. Use the **▼** and **▲** buttons to enter a deadband zone value around the setpoint where the output is not on. The PV must go beyond the deadband range in order for either the heating or cooling output to turn on. Press the **SET** button twice to save the selected value and return to the controller main screen.

## 12-8 Dual Cooling / Heating Loop with PID Control

1. Access the Initial Setup mode by pressing and holding the **SET** button for three seconds. Press the **↶** button repeatedly until the parameter **Ctrl** appears. Confirm the default value **PID** is selected for PID control. Press the **↶** button to access the parameter **S-HC**. Use the **↶** and **↷** buttons to select **H2C1** for controlling a dual cooling / heating loop. This parameter sets the cooling control to output #1 and the heating control to output #2. Press the **SET** button twice to save the value and return to the controller main screen.
2. Press the **↶** button to access the parameter **r--S**. Verify that the default value **rUn** is selected. Press the **SET** button to return to the controller main screen.
3. Refer to Section 12-1 of this Quick Start Guide to set up the PID control parameters.
4. If the temperature controller's output #1 is discrete, access the regulation mode again by pressing the **SET** button for less than three seconds. Press the **↶** button repeatedly until the parameter **CLPd** appears. Use the **↶** and **↷** buttons to set the time period in seconds for the cooling output. Press the **SET** button to save the value. If the temperature controller's output #2 is discrete, press the **↶** button repeatedly until the parameter **HCPd** appears. Use the **↶** and **↷** buttons to enter the cycle period for output #2, the heating output. Press the **SET** button twice to save the value and return to the controller main screen.
5. Optional regulation parameters can be programmed for additional dual loop control. If this is desired, access the regulation mode again by pressing the **SET** button for less than three seconds. Press the **↶** button repeatedly until the parameter **CoFF** appears. This value allows the heating control to have a different proportional setting than the cooling loop. The cooling loop proportional band setting is multiplied by the **CoFF** value to create a proportional band setting for the heating loop control. Use the **↶** and **↷** buttons to change this value if desired. Press the **SET** button to save the selected value. Press the **↶** button to access the parameter **DEAd**. Use the **↶** and **↷** buttons to enter a deadband zone value around the setpoint where the output is not effected by the proportional control value. As long as the PV remains within the deadband zone the output is not affected by the proportional control. The integral and derivative controls ignore the deadband setting and may cause the output to be on within the deadband zone. Press the **SET** button twice to save the value and return to the controller main screen.

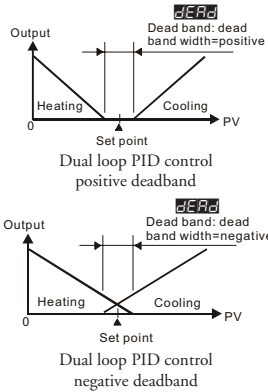

## 12-9 Dual Cooling / Heating Loop with ON / OFF Control

1. Access the Initial Setup mode by pressing and holding the **SET** button for three seconds. Press the **↶** button repeatedly until the parameter **Ctrl** appears. Use the **↶** and **↷** buttons to select **OnoF** for ON / OFF control and press the **SET** button to save the selected value. Press the **↶** button to access the parameter **S-HC**. Use the **↶** and **↷** buttons to select **H2C1** for controlling a cooling / heating loop. This parameter sets the cooling control to output #1 and the heating control to output #2. Press the **SET** button twice to save the value and return to the controller main screen.
2. Press the **↶** button to access the parameter **r--S**. Verify that the default value **rUn** is selected. Press the **SET** button to return to the controller main screen.
3. Press the **SET** button for less than three seconds to access the parameter **HLS**. Use the **↶** and **↷** buttons to enter hysteresis for output #2, the heating control. This is the amount the PV must go below the SV before the controller output turns on. Press the **SET** button to save the selected value. Press the **↶** button to access the parameter **CLS**. Use the **↶** and **↷** buttons to enter hysteresis for output #1, the cooling control. This is the amount the PV must go above the SV before the controller output turns on. Press the **SET** button twice to save the selected value and return to the controller main screen.
4. Optional regulation parameters can be programmed for additional dual loop control. If this is desired, access the regulation mode again by pressing the **SET** button for less than three seconds. Press the **↶** button repeatedly until the parameter **DEAd** appears. Use the **↶** and **↷** buttons to enter a deadband zone value around the setpoint where the output is not on. The PV must go beyond the deadband range in order for either the heating or cooling output to turn on. Press the **SET** button twice to save the selected value and return to the controller main screen.

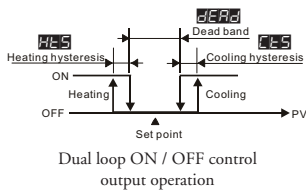

## 12-10 Ramp / Soak Control

1. Access the Initial Setup mode by pressing and holding the **SET** button for three seconds. Press the **↶** button repeatedly until the parameter **Ctrl** appears. Use the **↶** and **↷** buttons to select **Prog** for Ramp / Soak control. Press the **SET** button to save the selected value. Press the **↶** button to access the parameter **PRen**. Eight different Ramp / Soak patterns are possible with the Solo Temperature Controller. Use the **↶** and **↷** buttons to select pattern number 0 through 7 for programming. Press the **SET** button to save the selected value.
2. The chart below illustrates an example of a seven step Ramp / Soak pattern (Pattern 0). Press the **↶** button to access the parameter **SP00**. Use the **↶** and **↷** buttons to select a setting value temperature for step 00 and press the **SET** button to save the value. Press the **↶** button to access the parameter **ET00**. Use the **↶** and **↷** buttons to enter a time in hours / minutes for step 00. Follow this procedure until the desired number of temperature and time parameters are completed. Press the **↶** button to access the parameter **PS40**. Use the **↶** and **↷** buttons to select the last step to be completed by the Ramp / Soak pattern. For example, if **PS40** is set to **4**, steps 00 through 04 will be executed in the pattern.
3. Press the **↶** button to access the parameter **CYC0**. Use the **↶** and **↷** buttons to select the number of additional times the Ramp / Soak pattern will be executed. For example, if **CYC0** is set to **3**, the Ramp / Soak pattern will execute a total of four times. Press the **SET** button to save the selected value. Press the **↶** button to access the parameter **Lnk0**. Use the **↶** and **↷** buttons to choose a Ramp / Soak pattern to execute after the completion of Pattern 0. If set to **OFF**, the temperature of the last step in Pattern 0 will be held. Press the **SET** button twice to save the selected value and return to the controller main screen.

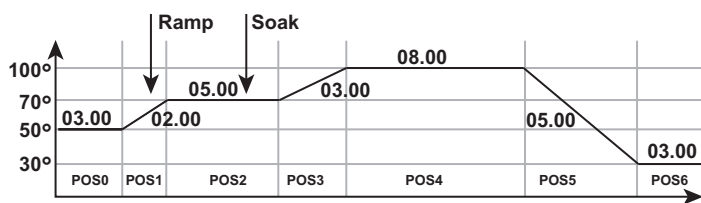

<b>SP00</b> Step00 = 50°	<b>SP03</b> Step03 = 100°	<b>SP06</b> Step06 = 30°
<b>ET00</b> Time00 = 3 hrs 00 min.	<b>ET03</b> Time03 = 3 hrs 00 min.	<b>ET06</b> Time06 = 3 hrs 00 min.
<b>SP01</b> Step01 = 70°	<b>SP04</b> Step04 = 100°	<b>PS40</b> Process Step = 6
<b>ET01</b> Time01 = 2 hrs 00 min.	<b>ET04</b> Time04 = 8 hrs 00 min.	<b>CYC0</b> Cycle times = 0
<b>SP02</b> Step02 = 70°	<b>SP05</b> Step05 = 30°	<b>Lnk0</b> Link = OFF
<b>ET02</b> Time02 = 5 hrs 00 min.	<b>ET05</b> Time05 = 5 hrs 00 min.	

## 12-11 Manual Control

1. Access the Initial Setup mode by pressing and holding the **SET** button for three seconds. Press the **↶** button repeatedly until the parameter **Ctrl** appears. Use the **↶** and **↷** buttons to select **MANU** for manual control. Press the **SET** button twice to save the selected value and return to the controller main screen.
2. Press the **↶** button to access the parameter **OUT1**. Use the **↶** and **↷** buttons to set a value between **00** and **1000** to control output #1 directly. If the controller has a discrete output, a value of **200** turns the output on 20% of the time. A value of **1000** would turn the output on 100% of the time. A manually controlled analog output value is a percentage of the analog signal. For example, if the controller has a 4-20mA current output, a setting of **40** would mean that the output would be 4mA. The output would be 20mA with a setting of **1000**. Both types of manually controlled outputs are off with a value of **00**. Press the **SET** button to save the selected value. For dual output control, press the **↶** button to access the parameter **OUT2**. Use the **↶** and **↷** buttons to set a value between **00** and **1000** to control output #2 directly. Press the **SET** button twice to save the selected value and return to the controller main screen.

## 13 Alarm Outputs

There are up to three groups of alarm outputs (ALA1, ALA2, ALA3\*). Each alarm group can be programmed for one of seventeen different alarm types. To set up the first alarm output, press the **SET** button for three seconds. Press the **↶** button repeatedly until the parameter **ALR1** appears. Use the **↶** button to choose the set value for the desired alarm type. Refer to the chart below for alarm type information. Press the **SET** button to save the selected value. If additional alarm outputs are required press the **↶** button to proceed to **ALR2** and/or **ALR3**\*. Follow the same procedure to program these additional alarms. When the desired alarms are programmed, press the **SET** button repeatedly until the controller returns to the main screen.

The alarm output limits are controlled by the parameters **ALnH** and **ALnL**, where "n" corresponds to the alarm output group chosen. After selecting the desired alarm group(s), press the **↶** button repeatedly until the parameter **ALnH** and/or **ALnL** appears. Use the **↶** and **↷** buttons to enter the high and/or low values for each group of alarm outputs selected. Press the **SET** button to save each selected value. Press the **SET** button again to return to the controller main screen.

ALA1 and ALA2 are both SPST resistive load 3A @ 250 VAC, normally open relay outputs. ALA3 uses the same output as output #2 and is the same type of output.

**\*Note: When output #2 is used, ALA3 is disabled. ALA3 is available only for single output loop control.**

Set Value	Alarm Type	Alarm Output Operation
0	Alarm function disabled	Output is OFF
1	Deviation upper and lower limit: This alarm output activates when the PV value is higher than the setting value SV + ALnH or lower than the setting value SV - ALnL.	ON: SV - ALnL, SV, SV + ALnH OFF: SV - ALnL, SV, SV + ALnH
2	Deviation upper-limit: This alarm output activates when the PV value is higher than the setting value SV + ALnH.	ON: SV + ALnH OFF: SV + ALnH
3	Deviation lower limit: This alarm output activates when the PV value is lower than the setting value SV - ALnL.	ON: SV - ALnL OFF: SV - ALnL
4	Reverse deviation upper and lower limit: This alarm output activates when the PV value is in the range of the setting value SV + ALnH and the setting value SV - ALnL.	ON: SV - ALnL, SV, SV + ALnH OFF: SV - ALnL, SV, SV + ALnH
5	Absolute value upper and lower limit: This alarm output activates when the PV value is higher than the setting value ALnH or lower than the setting value ALnL.	ON: ALnL, ALnH OFF: ALnL, ALnH
6	Absolute value upper-limit: This alarm output activates when the PV value is higher than the setting value ALnH.	ON: ALnH OFF: ALnH
7	Absolute value lower limit: This alarm output activates when the PV value is lower than the setting value ALnL.	ON: ALnL OFF: ALnL
8	Deviation upper and lower limit with standby sequence: This alarm output activates when the PV value reaches the set point (SV value) and the reached value is higher than the setting value SV + ALnH or lower than the setting value SV - ALnL.	ON: SV - ALnL, SV, SV + ALnH OFF: SV - ALnL, SV, SV + ALnH
9	Deviation upper limit with standby sequence: This alarm output activates when the PV value reaches the set point (SV value) and the reached value is higher than the setting value SV + ALnH.	ON: SV + ALnH OFF: SV + ALnH
10	Deviation lower limit with standby sequence: This alarm output activates when the PV value reaches the set point (SV value) and the reached value is lower than the setting value SV - ALnL.	ON: SV - ALnL OFF: SV - ALnL
11	Hysteresis upper-limit alarm output: This alarm output activates when the PV value is higher than the setting value SV + ALnH. This alarm output is OFF when the PV value is lower than the setting value SV + ALnL.	ON: SV + ALnH OFF: SV + ALnL
12	Hysteresis lower-limit alarm output: This alarm output activates when the PV value is lower than the setting value SV - ALnL. This alarm output is OFF when the PV value is higher than the setting value SV - ALnL.	ON: SV - ALnL OFF: SV - ALnH
13	N/A	

### Ramp / Soak Program Alarms

14	This alarm activates when the Ramp / Soak program has ended.	
15	This alarm activates while the program is in RAMP UP status.	
16	This alarm activates while the program is in RAMP DOWN status.	
17	This alarm activates while the program is in SOAK status.	
18	This alarm activates while the program is in RUN status.	

**Note: ALnH includes AL1H, AL2H and AL3H. ALnL includes AL1L, AL2L and AL3L.**

## 14 Error Display Information

The chart below shows the possible error displays on the Solo temperature controller.

Controller Error Display				
Display Position	Display	Meaning	Cause	Corrective Action
PV	b 160	Initialization PV = Firmware version SV = Module type	The controller is in the initialization process.	The Solo controller displays this information for a few seconds after power up. If the controller continues displaying this information, check the input wiring. If the problem still exists, replace the sensor or the controller.
PV	no	No sensor input	The input terminals are open.	Check the input wiring. If the problem still exists, replace the sensor or the controller.
PV	Err	Input error	The controller cannot read the input value	Check the sensor and the input wiring. If the problem still exists, replace the sensor or the controller.
PV	Err	EEPROM error	There is an error with the EEPROM	Cycle the power to the Solo controller. If the problem still exists, replace the controller.
PV	Flashing PV	PV out of range	The PV is out of range	Check the PV range. The parameters <b>EP-H</b> and <b>EP-L</b> define the range. Refer to section 12-1, 12-2 or 12-3 for directions on how to access these parameters.